

INSTRUCTION MANUAL

DVD-X5

DVD Player

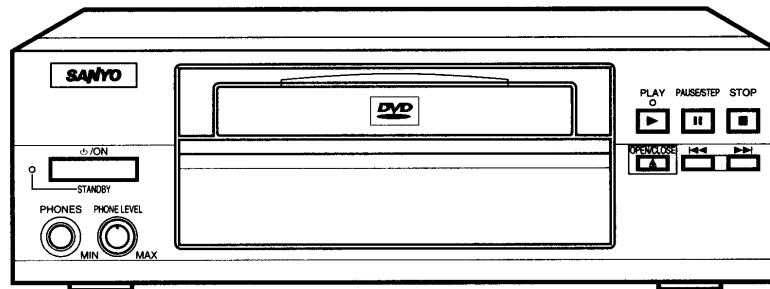

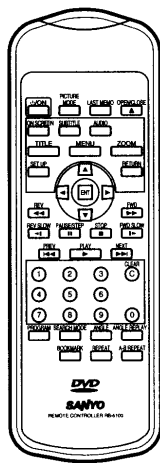

PRECAUTIONS

CAUTION

THIS PRODUCT CONTAINS A LOW POWER LASER DEVICE, TO ENSURE CONTINUED SAFETY DO NOT REMOVE ANY COVERS OR ATTEMPT TO GAIN ACCESS TO THE INSIDE OF THE PRODUCT.

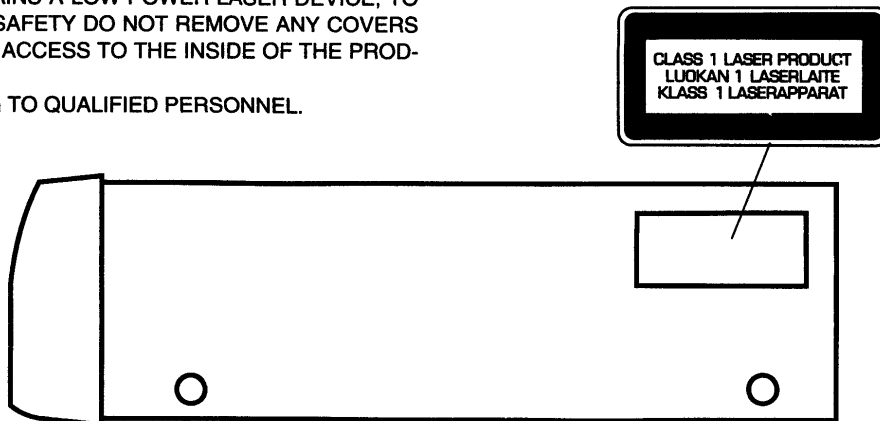
REFER ALL SERVICING TO QUALIFIED PERSONNEL.



- The apparatus shall not be exposed to dripping or splashing.
- Do not use where there are extremes of temperature (below 5°C or exceeding 35°C) or where direct sunlight may strike it.
- Because of the DVD player's extremely low noise and wide dynamic range, there might be a tendency to set the volume on the amplifier unnecessarily high. Doing so may produce an excessively large output from the amplifier which could damage your speakers.
- Sudden changes in the ambient temperature may cause condensation to form on the optical lens inside the unit. If this happens, take out the disc, leave the unit for about 1 hour, and then proceed to operate.
- When carrying the unit, be sure to remove any discs which may be inside and turn the power off. Wait at least 10 seconds, then unplug the mains lead from the AC outlet. Carrying the unit with any discs inside may damage the disc and/or the unit.
- Do not install this equipment in a confined space, such as a book case or built in cabinet.
- The DVD player is not completely disconnected from the mains when the /ON button is set to the  position.

Important Information:

To connect this DVD player to a TV, TV must have a set of Audio/Video composite input sockets or a Euro-AV socket. You cannot use an aerial terminal to connect this DVD player.

This product incorporates copyright protection technology that is protected by method claims of certain U.S. patents and other intellectual property rights owned by Macrovision Corporation and other rights owners. Use of this copyright protection technology must be authorized by Macrovision Corporation, and is intended for home and other limited viewing uses only unless otherwise authorized by Macrovision Corporation. Reverse engineering or disassembly is prohibited.

IMPORTANT

If the plug supplied with this equipment is not suitable for the socket outlets in your home it should be cut off and replaced with the correct type.

Disposal of Plug

If the non rewirable plug is to be cut off, the removed plug should be disposed of carefully as there is a shock hazard should the plug be inserted into a live socket.

Replacing Fuse

The detachable fuse cover must be replaced after changing the fuse. Only a 3A fuse should be used and should comply with BS1362 and should carry the ASTA mark .

The wires in the mains lead are coloured in accordance with the following code;

Blue	Neutral
Brown	Live

The wires in the mains lead must be connected to the terminals in the plug as follows;

Wire colour	Plug terminal marking
Blue	N or Black or Blue
Brown	L or Red or Brown

Do not connect either wire to the earth terminal.

If the mains plug contains a fuse this should be 3A, if a plug without a fuse is used the distribution board fuse should not be greater than 5A.

The unit is not disconnected from the mains unless it is unplugged from the AC outlet.

CONTROLS

Front panel

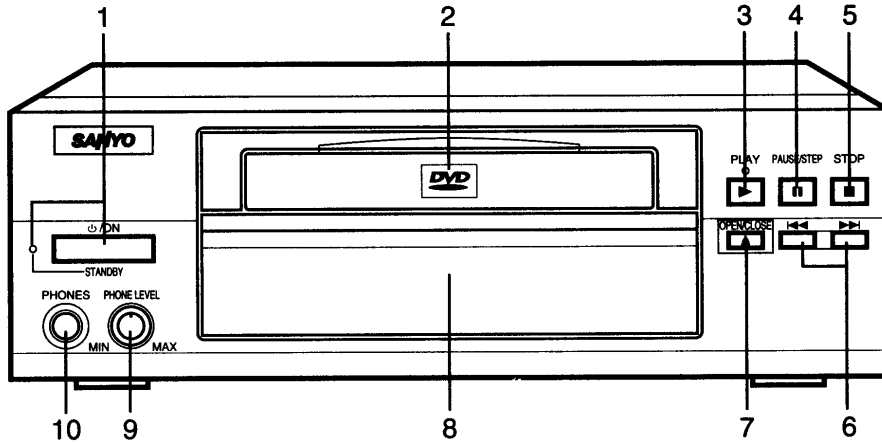

- | | |
|---|--|
| 1. Power button/Standby indicator (⏻/ON, STANDBY) | 6. Skip/Next/Previous buttons (⏮, ⏭, ⏪, ⏩) |
| 2. Disc tray | 7. Open/Close button (OPEN/CLOSE) |
| 3. Play button/indicator (PLAY) | 8. Display |
| 4. Pause/Step button (PAUSE/STEP) | 9. Headphones volume control (PHONE LEVEL) |
| 5. Stop button (STOP) | 10. Headphones socket (PHONES) |

Display

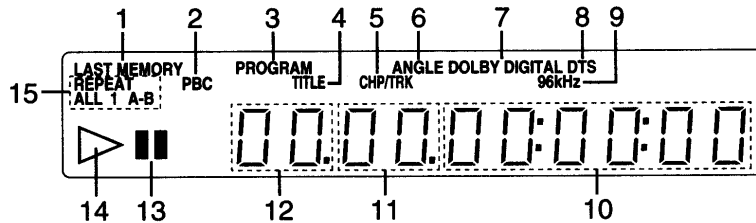

- | | |
|--|---|
| 1. Last memory indicator (LAST MEMO) | 9. PCM 96kHz sampling frequency indicator (96kHz) |
| 2. Playback control indicator for Video CD (PBC) | 10. Elapsed and Remaining playing time indicator |
| 3. Programme indicator (PROGRAM) | 11. Chapter and Track number indicator |
| 4. Title indicator (TITLE) | 12. Title number indicator |
| 5. Chapter/Track indicator (CHP/TRK) | 13. Pause indicator (⏸) |
| 6. Angle indicator (ANGLE) | 14. Play indicator (▶) |
| 7. Dolby Digital indicator (DOLBY DIGITAL) | 15. Repeat mode indicators (REPEAT, ALL, 1, A-B) |
| 8. DTS indicator (DTS) | |

Rear panel

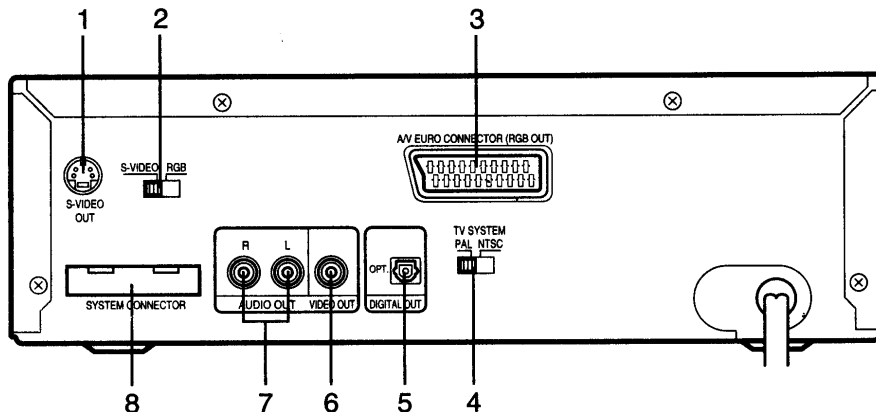

- | | |
|--|--|
| 1. S-Video output socket (S-VIDEO OUT) | 5. Optical digital output socket (DIGITAL OUT) |
| 2. Video out select switch (S-VIDEO/RGB) | 6. Video output socket (VIDEO OUT) |
| 3. Euro AV socket (A/V EURO CONNECTOR) | 7. Audio output sockets (AUDIO OUT) |
| 4. TV system select switch (TV SYSTEM) | 8. System connector socket (SYSTEM CONNECTOR) |

REMOTE CONTROL (RB-5100)

Controls

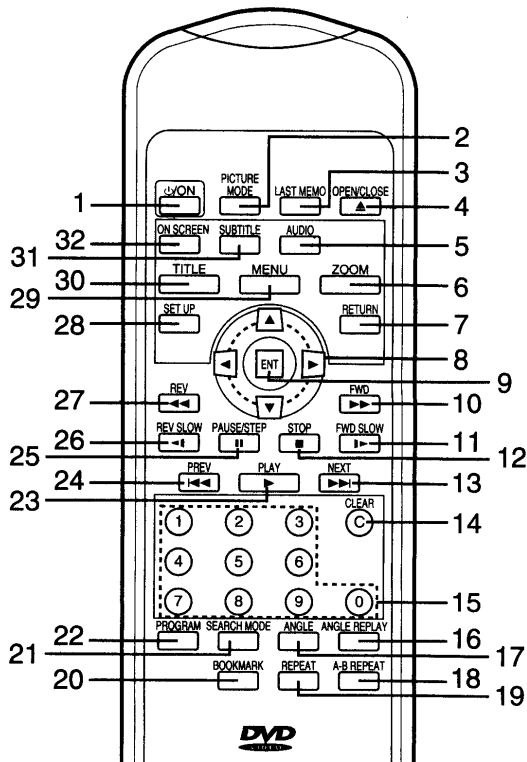

1. Power button (ON/OFF)
2. Picture mode button (PICTURE MODE)
3. Last memory button (LAST MEMO)
4. Open/Close button (OPEN/CLOSE)
5. Audio button (AUDIO)
6. Zoom button (ZOOM)
7. Return button (RETURN)
8. Directional arrow buttons (▲, ▶, ▼, ◀)
9. Enter button (ENT)
10. Forward button (FWD)
11. Forward slow button (FWD SLOW)
12. Stop button (STOP)
13. Skip/Next button (NEXT)
14. Clear button (CLEAR)
15. Number buttons (1 – 9, 0)
16. Angle replay button (ANGLE REPLAY)
17. Angle button (ANGLE)
18. A-B repeat button (A-B REPEAT)
19. Repeat button (REPEAT)
20. Bookmark button (BOOKMARK)
21. Search mode button (SEARCH MODE)
22. Programme button (PROGRAM)
23. Play button (PLAY)
24. Skip/Previous button (PREV)
25. Pause/Step button (PAUSE/STEP)
26. Reverse slow button (REV SLOW)
27. Reverse button (REV)
28. Set up button (SET UP)
29. Menu button (MENU)
30. Title button (TITLE)
31. Subtitle button (SUBTITLE)
32. On screen display button (ON SCREEN)

Inserting batteries

Install two "R6 (HP 7)" batteries (not supplied) as shown below.

1

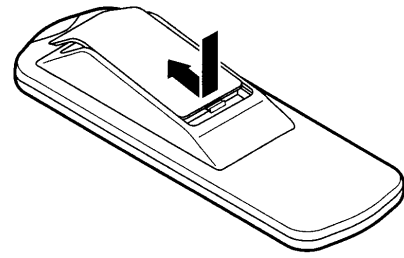

2

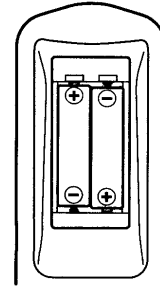

Note:

Remove the batteries if the remote control is not to be used for a month or more. Batteries left in the unit may leak and cause damage.

Remote control range

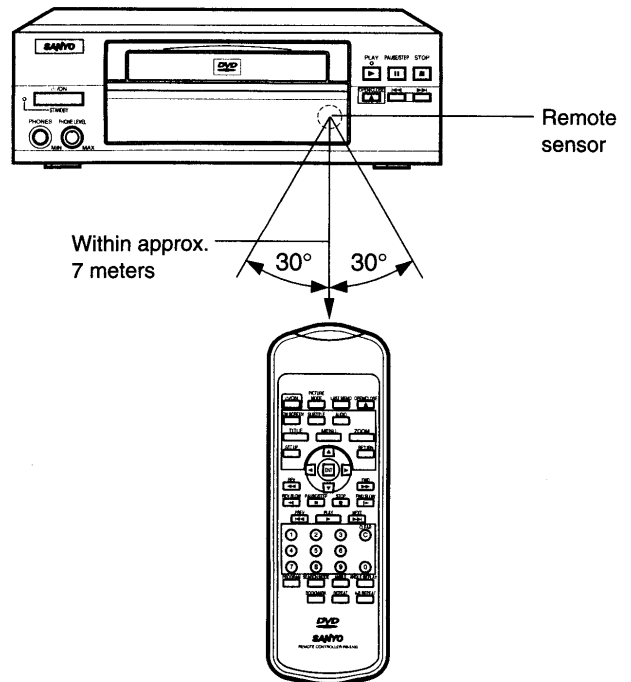

CONNECTIONS

Connecting to a TV with an Audio/Video cable

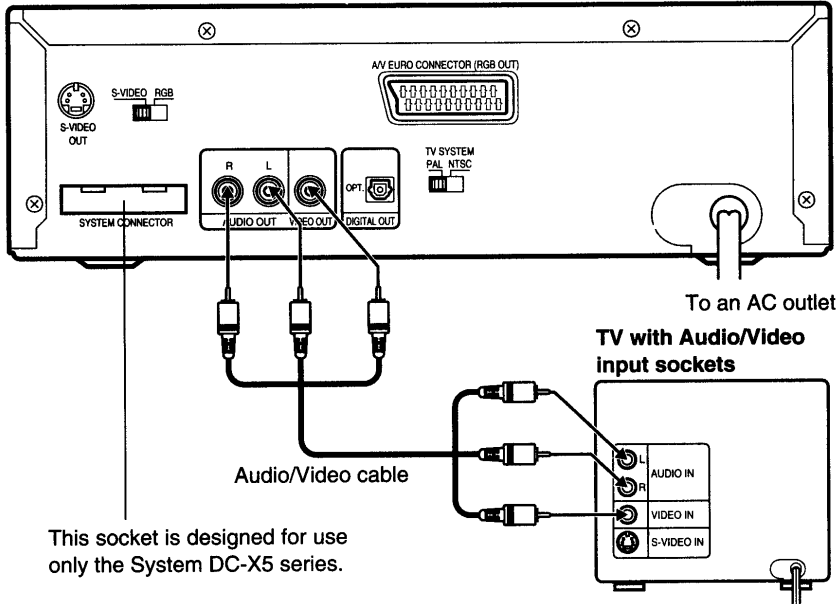

Notes on connections

- **Selecting TV system:** Be sure the TV SYSTEM switch (rear of the unit) setting corresponds with your local TV system (PAL or NTSC).
- **Do not connect the DVD player to a VCR directly. The playback picture will be distorted because DVD discs are copy protected.**
- When you connect the DVD player to your TV and other equipment, be sure to turn off the power and disconnect all of the equipments from the wall outlet until all the connections have been made.
- Please refer to the instruction manuals for the components that you are connecting (TV, AV amplifier, etc.).

Connecting to a TV with an Audio and S-video cables

If your TV has a S-video input socket, connect the DVD player as shown below. (The VIDEO OUT socket connection is not necessary.) You can enjoy clearer picture playback.

Select "S-VIDEO" when using the S-VIDEO OUT socket.

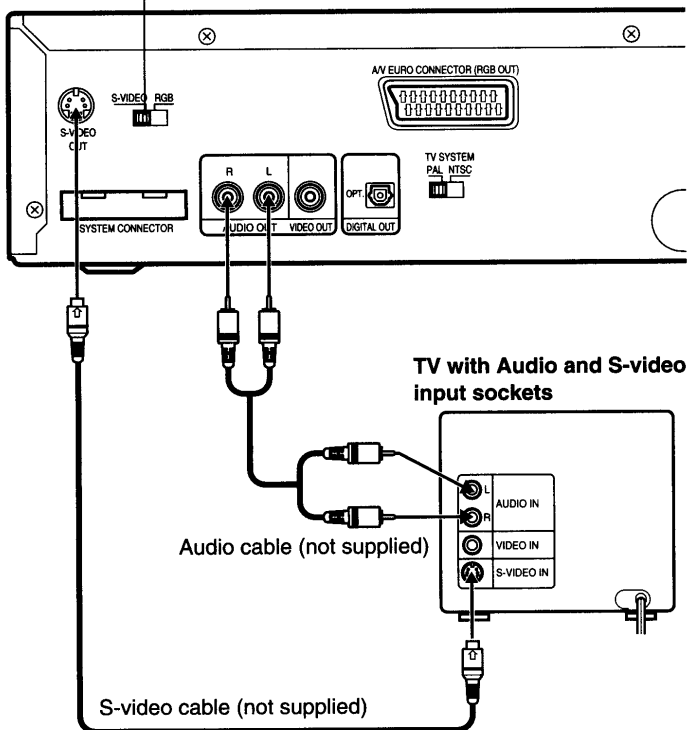

Connecting to a TV with a EURO-AV cable

If your TV has a EURO-AV socket, connect the DVD player as shown below. (The AUDIO and VIDEO OUT sockets connections are not necessary.)

Select "RGB" when using the AV EURO CONNECTOR.

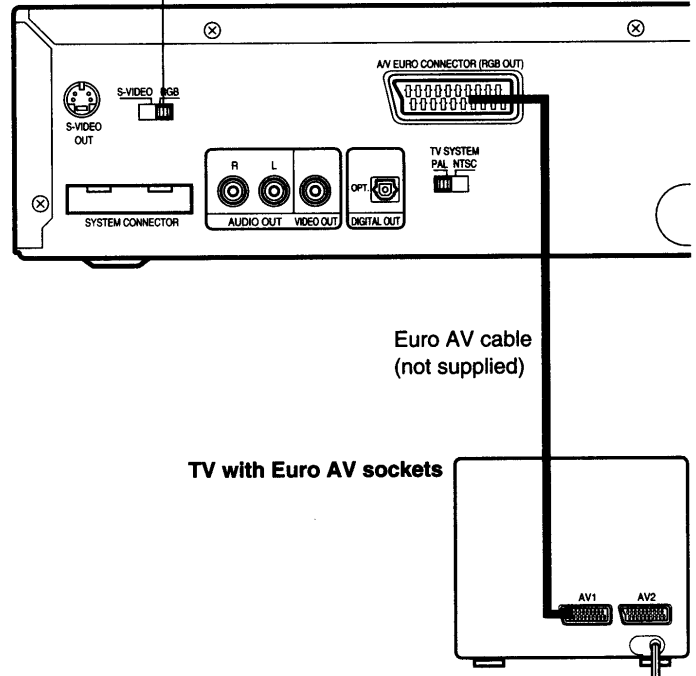

Connecting to a HiFi system with analog two-channel stereo sound

As an alternative to using the TV's speakers, the sound can also be played back through a HiFi system.

Connect an audio cable (not supplied) to the AUDIO OUT sockets of the DVD player and to the appropriate sockets of the HiFi system.

- The AUDIO OUT sockets can also be used for connection to an AV system with Dolby Pro Logic decoder.

Connecting to a digital multi-channel AV amplifier

The digital multi-channel sound of a DVD can best be decoded and played with a multi-channel AV amplifier (MPEG audio decoder or Dolby Digital decoder).

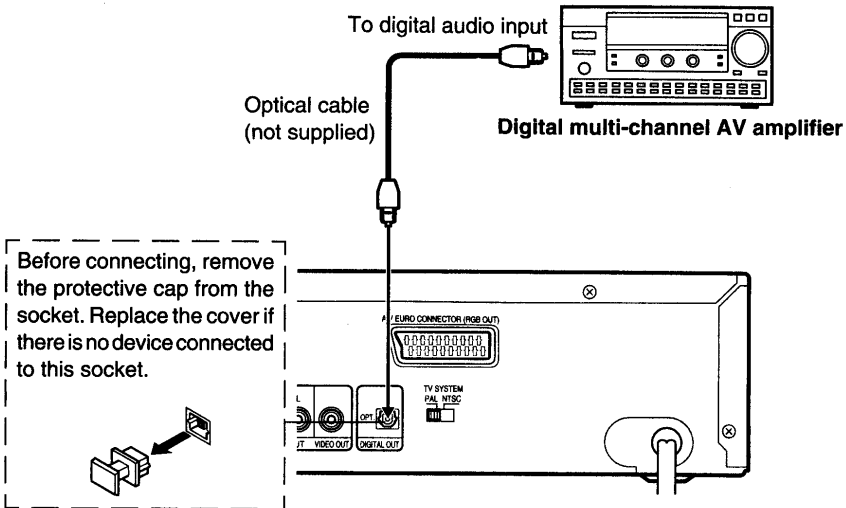

The AV amplifier has to be able to process the DTS audio signal in order to play a DVD with DTS. If it cannot, then you will not be able to hear the DVD.

Note:

- To enjoy Dolby Digital sound, select "Dolby Digital: 5.1ch" in AUDIO on the INITIAL SETTINGS. (See Page 12.)
- To enjoy MPEG sound, select "MPEG: MPEG" in AUDIO on the INITIAL SETTINGS. (See Page 12.)
- To enjoy DTS sound, select "DTS: ON" in AUDIO on the INITIAL SETTINGS. (See Page 12.)

Headphones





Connect stereo headphones (not supplied) to the PHONES socket for monitoring or for private listening. Use the PHONE LEVEL control to adjust the volume of the headphones.

Manufactured under license from Dolby Laboratories. "Dolby", "Pro Logic" and the double-D symbol are trademarks of Dolby Laboratories. Confidential Unpublished Works. ©1992-1997 Dolby Laboratories, Inc. All rights reserved.

"DTS" and "DTS Digital Out" are trademarks of Digital Theater Systems, Inc.

PLAYABLE DISCS

The following types of discs can be played on this unit.

Disc type and logo mark		Recorded content	Disc size	Maximum playing time
DVD Video		Audio + Video	12 cm	Approx. 4 hours (Single sided disc) Approx. 8 hours (Double sided disc)
			8 cm	Approx. 80 minutes (Single sided disc) Approx. 160 minutes (Double sided disc)
Video CD	 	Audio + Video	12 cm	74 minutes
			8 cm	20 minutes
Music CD		Audio	12 cm	74 minutes
			8 cm	20 minutes

Region number

Region number (Regional restriction code) is built-in to the DVD player and DVD discs.

There is a region number on the rear of the unit.

The same region number or region number "ALL" of DVD discs can be used on this unit.

DVD disc

There are the marks on some DVD disc package.

Examples:

 Multiple Languages

 Multi-language subtitles

 Multi-Angle

 Multi-Aspect

 Region number

Note:

- Only the above types of discs can be played on this unit. DVD-ROM, CD-ROM, SVCD, CVD, etc. cannot be played.
- CD-R can be played back, but it depends on the recorded condition.
- This unit is to be used exclusively with the NTSC or PAL colour system. SECAM system discs cannot be used with this unit.

DVD discs are divided into titles, and the titles are sub-divided into chapters.

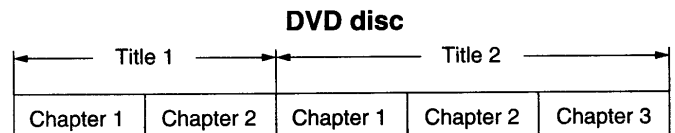

Video CD/Music CD disc

Video CD and Music CD discs are divided into tracks.

Video CD/Music CD disc

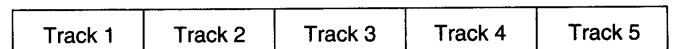

Notes on handling discs

- Do not expose the disc to direct sunlight, high humidity or high temperatures for extended periods of time.
- Discs should be returned to their cases after use.
- Do not apply paper or write anything on the disc surface.
- Handle the disc by its edge. Do not touch the playing surface (glossy side).
- Fingerprints and dust should be carefully wiped off the playing surface of the disc with a soft cloth.
Wipe in a straight motion from the centre to the outside of the disc.
- Never use chemicals such as record cleaning sprays, antistatic sprays or fluids, benzene or thinner to clean discs.

BASIC OPERATION

Important note:

- This instruction manual explains the basic instruction of this DVD player using the remote control unit (RB-5100).
- Some DVD or Video CD discs have different functions that may not be explained in this instruction manual. You may be needed extra instructions. In this case, please follow the instructions displayed on the TV screen or jacket or case of the disc.
- "⊘" may appear on the TV screen during operation. This icon means that the function is not available on the disc now.

Before starting

- Turn on the TV and select the channel for the DVD player. Select the playback picture size according to the aspect ratio of the TV.
- Turn on the HiFi system, AV amplifier, etc. and select the audio input for the DVD player.

Basic play

Note:

- Do not touch the disc tray while it is moving.
- Never place anything except a disc on the disc tray. Foreign objects can damage the unit.
- Do not apply excessive force to the disc tray.
- Discs must be placed on the disc tray one at a time.

When operation buttons are pressed, that operation is displayed on the TV screen. The display turns off after several seconds.

1. Press the /ON button.
 - The STANDBY indicator turns off and the displays light.
 - "SANYO" logo appears on the TV screen.
 - "READING" then "NO DISC" appears on the display.

2. Press the OPEN/CLOSE button.

- "OPEN" appears and the disc tray opens.

Note:

To open or close the disc tray, be sure to use the OPEN/CLOSE button. Do not press the disc tray with your hand.

3. Place the disc with the label facing up on the disc tray.

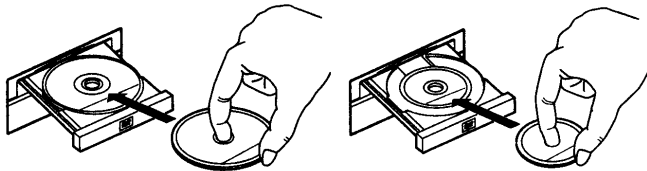

For 12 cm disc

For 8 cm disc

4. Press the PLAY button. The disc tray closes then play starts automatically.

- "Play ►" briefly appears on the screen.
- "CLOSE", "READING", "DVD" (or "VCD" or "CD") then the title/ chapter (or track) number and elapsed playing time appear on the display.

Note:

If the disc is loaded with the label side downward (and it is a single sided disc), or if a badly scratched disc is loaded, "NO DISC" (or "DISC ERROR" or "NO PLAY") appears. If this occurs, load the disc correctly or replace the disc.

If a menu screen appears on the TV screen...

Press the ▲, ►, ▼ or ◀ button (or the number buttons), then press the ENT button to select the desired item. Playback of the selected item will start.

Note:

For more details, please refer to the jacket or case of the disc.

Stopping play

Press the STOP button once. The player memories the point where you stopped. If you press the PLAY button, play starts automatically from the point where you stopped. (Resuming Playback)

Note:

- Some discs may not start resuming playback.
- If the STOP button is pressed twice, the player stops completely.

Continuing play from where you stopped watching (LAST MEMO PLAY)

Note:

You must set "LastMemo Play: ON" first. (See Page 12.)

1. During play, press the LAST MEMO button at the point from which you want to resume play later. "Last Memo" briefly appears on the screen. "LAST MEMORY" appears on the display. Play stops automatically.
2. Remove the disc or turn off the power.
3. Load the disc (and press the PLAY button), or turn on the power. "Last Memo Play" briefly appears on the screen. Play resumes from the point where you stopped. (The memory is released.) If desired, press the LAST MEMO button again.

Note:

- Points on up to 5 discs can be memorized.
- The Last Memo Play mode may not work correctly with some discs.

VARIOUS PLAYING FUNCTIONS

Chapter (Track) skip



Skipping forward

Press the NEXT button (or the ►► button on the front panel) during play to skip to the next chapter (or track). A chapter (or track) is skipped each time the button is pressed.

Skipping back

Press the PREV button (or the ◀◀ button on the front panel) during play to skip back to the beginning of the chapter (or track) currently play. Press the button again immediately to skip back to the beginning of the previous chapter (or track).

Title/Chapter (Track) search

1. Press the SEARCH MODE button once during play or in the stop mode. "TITLE/CHAPTER SEARCH" or "TRACK SEARCH" screen appears.
2. Press the number buttons to enter the title (or track) number.
3. Press the ▼ button.
4. Press the number buttons to enter the chapter number. (For Video CD and Music CD, skip this step.)
Note:
 - If you made a mistake, press the CLEAR button.
 - To quit this menu, press the SEARCH MODE button twice.
5. Press the ENT button. The selected title and chapter (or track) play starts.

Time search

1. Press the SEARCH MODE button twice during play. "TIME SEARCH" screen appears.
2. Press the number buttons to enter the time.
Example:
20 minutes 5 seconds Press 2, 0, 0 and 5.
1 hour 4 minutes 35 seconds Press 1, 0, 4, 3 and 5.
Note:
 - If you made a mistake, press the CLEAR button.
 - To quit this menu, press the SEARCH MODE button.
3. Press the ENT button. Play starts from the searched time.

"⊙" may appear on the TV screen during operation. This icon means that the function is not available on the disc now.

Fast play

Press the FWD or REV button repeatedly to select the fast speed forward or reverse play.

DVD/Video CD:

"FF1 ►►", "FF2 ►►", "FF3 ►►" or "FR1 ◀◀", "FR2 ◀◀", "FR3 ◀◀"

Music CD:

"FF1 ►►", "FF2 ►►" or "FR1 ◀◀", "FR2 ◀◀"

Press the PLAY button to return to normal play.

Slow-motion play

Forward slow play [DVD], [Video CD]/Reverse slow play [DVD]

Press the FWD SLOW or REV SLOW button repeatedly to select the forward or reverse slow speed play.

"SF1 ►", "SF2 ►", "SF3 ►" or "SR1 ◀", "SR2 ◀", "SR3 ◀"

Press the PLAY button to return to normal play.

Note:

The sound is muted during fast play or slow-motion play.

Still picture (Pause)

[DVD], [Video CD]: Still picture mode, [CD]: Pause mode

Press the PAUSE/STEP button during play. "II" appears on the display. "Pause II" appears on the TV screen. Press the PLAY button to resume normal play.

Note: The sound is muted.

Frame by frame advance play [DVD], [Video CD]

Press the PAUSE/STEP button during still play. "Step II►" appears on the screen. Each time the button is pressed, the picture advances one frame. Press the PLAY button to resume normal play.

Note:

- The sound is muted.
- Frame play is operated forward only.

Zoom feature [DVD]

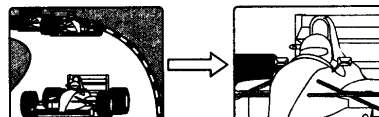

1. Press the ZOOM button during normal play or still play. The player magnifies the image (2 times) in the centre of the picture.
2. Press the ▲, ▼, ◀ or ► button to change the zoom point.
3. To return to normal play or still play, press the ZOOM button again.

Note:

Some discs may not work Zoom feature.

Viewing from a desired camera angle (Multi-Angle)

Some DVD discs may contain scenes which have been shot simultaneously from a number of different camera angles.

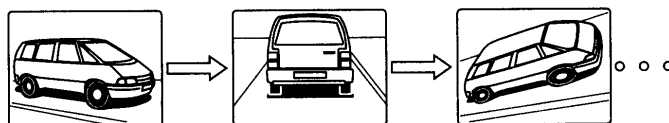

The jacket or case of discs that are recorded with angles will be marked. Example:



Note: The recorded angles differ depending on the disc used.

1. Play the disc that is recorded with angles.
2. Press the ANGLE button repeatedly until the desired angle appears.

Example:

Angle
03

Angle replay

During Multi-angle play screen, press the ANGLE REPLAY button.

The player skips back to last approximately 10 seconds, changes it to the next camera angle and plays it, and continues play.

If desired, press the button again.

Normal repeat play

Press the REPEAT button during play (or programmed play) of the title or chapter (or track) you want to repeat.

Each time the button is pressed, the repeat mode changes as follows.

[DVD]

All Repeat: Repeat all titles

Title Repeat: Repeat of title being played

Chapter Repeat: Repeat of chapter being played

(Program Repeat: Repeat programmed play)

Clear: Normal play mode

[Video CD], [CD]

All Repeat: Repeat all tracks

Repeat 1: Repeat of track being played

(Program Repeat: Repeat programmed play)

Clear: Normal play mode

Note:

When "All Repeat" appears on the TV screen, "REPEAT ALL" appears on the display. But, "REPEAT 1" appears on the display in all other repeat modes.

Designated range repeat play (A-B Repeat)

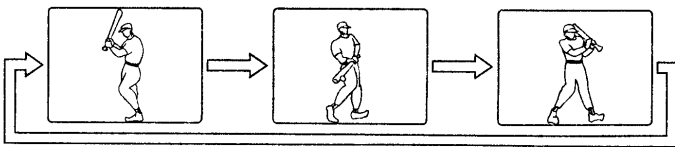

1. Press the A-B REPEAT button during play at the beginning of the section you want to repeat (Point A). "Repeat A-" appears on the screen. "REPEAT A-B" blinks on the display.

2. Press the A-B REPEAT button again at the end of the section (Point B). "Repeat A-B" briefly appears on the screen. "REPEAT A-B" remains lit on the display.

The section between points A and B is played repeatedly.

Note:

For Video CD, wait 2 seconds at least before pressing the button.

3. To return to normal play, press the A-B REPEAT button again.

Note:

Normal repeat play or A-B repeat play mode may not work correctly with some discs.

Return button (RETURN) for Video CD

Normally, it returns to the previous menu during play when the RETURN button is pressed.

Note:

The operation differs according to the content of the Video CD.

Programmed play

Up to 32 selections can be programmed.

Programming procedure

1. Press the PROGRAM button during play or stop mode. "PROGRAM" screen appears. "PROGRAM" blinks and "Pr 1" appears on the display.
2. Press the ▲, ▼, ◀ or ▶ button to select the title, chapter or track.
3. Press the ENT button.
4. Repeat steps 2-3 above to select another title, chapter or track.

Example:

PROGRAM		
ALL CLEAR	TITLE	CHAPTER
No. : T, C	-	All
1 : 2, 5	1	1
2 : -, -	2	2
3 : -, -	3	3
4 : -, -	4	4
5 : -, -		5
6 : -, -		6
7 : -, -		
8 : -, -		
9 : -, -		
10 : -, -		

Programme number

Note:

If you want to quit this menu, press the PROGRAM button.

5. Press the PLAY button to start play. "PROGRAM" remains lit on the display.

Note:

If you wish to play the programme again, press the PROGRAM button to call up the programme screen then press the PLAY button.

To clear the programme one by one

In the programming mode, press the ▲, ▼, ◀ or ▶ button to select the programme number. Then press the CLEAR button.

To clear all the programmes

In the programming mode, press the ▲, ▼, ◀ or ▶ button to select "ALL CLEAR". Then press the ENT button.

Setting and playing bookmarks

Up to five bookmarks can be memorized for the last five discs played, then select them directly for playback.

Note: Some discs may not work bookmark function.

Setting or clearing bookmarks

1. Press the BOOKMARK button during play. "BOOKMARK" screen appears.

Example:

BOOKMARK	
No :	T, C
1 :	NONE
2 :	NONE
3 :	NONE
4 :	NONE
5 :	NONE

2. Press the ▲ or ▼ button to select the bookmark number.

- Press the ENT button at the starting point to be viewed (listened to) again.

Example:

```

BOOKMARK
No :           T, C
1 : ENTRY     1, 6
2 : NONE
3 : NONE
4 : NONE
5 : NONE

```

Note:

- If you made a mistake, press the CLEAR button.
- To quit this menu, press the BOOKMARK button.

Recalling a bookmark

- Press the BOOKMARK button.
- Press the ▲ or ▼ button to select the bookmark to be recalled.
- Press the PLAY button. Play resumes from the point corresponding to the selected bookmark.

Clearing a bookmark

- Press the BOOKMARK button.
- Press the ▲ or ▼ button to select the bookmark to be cleared then press the CLEAR button.

Selecting a title menu

- Press the TITLE button. A list of the titles on the disc appears.
Note: Press the TITLE button again to resume play from the scene when the TITLE button was first pressed.
- Press the ▲, ▼, ◀ or ▶ button (or the number buttons) to select the desired title.
- Press the ENT button. The selected title play starts.

Selecting a DVD menu

- Press the MENU button. The main menu screen appears.
Note: Press the MENU button again to resume play.
- Press the ▲, ▼, ◀ or ▶ button (or the number buttons) to select the desired menu.
- Press the ENT button. The selected menu play starts.

Note:

- The selecting a title menu or DVD menu operation may differ depending on the disc used.
- Selecting a title menu or DVD menu may not be possible on some discs.

Selecting subtitle language

This operation works only with discs on which multiple subtitle languages are recorded.

- Press the SUBTITLE button during play. "SUBTITLE MODE" screen appears.
- Press the ▲, ▼, ◀ or ▶ button to select the desired subtitle language then press the ENT button.

Note:

- In some cases, the subtitle language is not changed to the selected one.
- When a disc supporting the closed caption is played, the subtitle and the closed caption may overlap each other on the TV screen. In this case, turn the subtitle off.
- When the desired language is not selected even if the button is pressed, the language is not available on the disc.
- When the power is turned on or the player is stopped completely or the disc is replaced, select the subtitle language again.
- If the subtitle language is not necessary, select "OFF".

Selecting audio soundtrack language (Multi-Language)

This operation works only with discs on which multiple audio soundtrack languages are recorded.

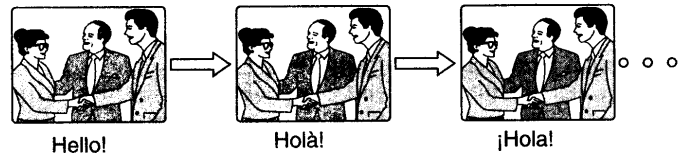

- Press the AUDIO button during play.
- Press the AUDIO button repeatedly until the desired language appears on the screen.

Example:

```

Language Change
02 GER

```

Note:

- When the desired language is not selected even if the button is pressed, the language is not available on the disc.
- When the power is turned on or the player is stopped completely or the disc is replaced, select the language again.
- If the language is not recorded on the disc, only the available language on the disc will be heard.
- If "Others" is selected, enter the language code. (See "LANGUAGE CODE LIST".)

Changing the audio channel output [Video CD], [CD]

During Video CD/CD play, press the AUDIO button to select an audio channel.

LEFT MONO → RIGHT MONO → STEREO → LEFT MONO ...

Selecting picture mode

Press the PICTURE MODE button. Each time the button is pressed, the picture mode changes as follows:

PICTURE MODE

Standard → Mild → Black and White → Standard ...

Selecting display mode

Press the ON SCREEN button to show the disc information (Title, Chapter, Title pass time, etc.).

Example:

DVD		Play ▶
TITLE: 01	Title pass time	00:05:45
CHAPTER: 04	Chapter pass time	00:00:51

```

AUDIO: ENG
Dolby Digital 5.1ch
SUBTITLE: ENG
ANGLE: 1

```

DVD		Play ▶
TITLE: 01	Title remain time	00:56:07
CHAPTER: 14	Chapter remain time	00:00:37

```

AUDIO: ENG
Dolby Digital 5.1ch
SUBTITLE: Others
ANGLE: 1

```

INITIAL SETTINGS

Once the initial settings have been completed, the player can always be operated under the same conditions. The settings will be retained in the memory until they are changed, even if the power is turned off.

Common procedures of initial settings



1. Press the SET UP button in the stop mode. "SET UP MENU" screen appears on the TV screen.
2. Press the ▲, ▼, ◀ or ▶ button, then press the ENT button to select the menu. Please follow these on the screen.
3. Press the SET UP button to quit this menu.

Example:

SET UP MENU		
LANGUAGE	OSD:	ENG
		ENG
		GER
		FRE
		ITA
		SPA
		POR
		DAN
		SWE
		FIN
	AUDIO:	DISC
		DISC
		ENG
		GER
		FRE
		ITA
		SPA
		POR
		DAN
		SWE
		FIN
		Others
	SUBTITLE:	DISC
		DISC
		ENG
		GER
		FRE
		ITA
		SPA
		POR
		DAN
		SWE
		FIN
		Others
	DVD MENU:	DISC
		DISC
		ENG
		GER
		FRE
		ITA
		SPA
		POR
		DAN
		SWE
		FIN
		Others

Note:

- You cannot switch audio sound track languages if there is only one language recorded on the disc.
- When you play a DVD disc, the player automatically displays the pre-selected subtitle language if it is included on the disc.
- If "Others" is selected, enter the language code. (See "LANGUAGE CODE LIST".)

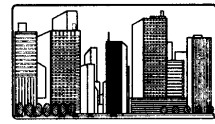
DISPLAY	TV TYPE:	4:3 LT	4:3 LT	Select the appropriate your TV screen size.	
			4:3 PS	4:3 LT (Letterbox): Select when a conventional TV set is connected. When the wide screen disc is played back, the black bands appear at the top and bottom of screen.	
			16:9		
	SCREEN SAVER:	ON	ON		
		OFF	OFF		
	LastMemo Play:	ON	ON	4:3 PS (Panscan): Select when a conventional TV set is connected. When the wide screen disc is played back, it displays pictures cropped to fill to your TV screen. The left and right edges are cut off.	
		OFF	OFF		
			16:9 : Select when a wide screen TV set is connected. Played in "FULL" size. (Setting the wide screen TV to "FULL" mode is also necessary.)		

- Note:
- The screen size may differ depending on the DVD discs.
 - If you select 16:9 to get rid of the black bands on screen when wide screen disc is played back, picture may be slightly distorted.
 - In some discs, even if 4.3 PS is selected, the black bands will remain on the screen.

AUDIO	DIGITAL OUT:	ON	ON	(Note: It is "ON" only.)
	Dolby Digital:	2ch	5.1ch 2ch	Select PCM "2ch" or Dolby Digital "5.1ch".
	MPEG:	PCM	MPEG PCM	Select PCM or MPEG signal.
	DTS:	OFF	ON OFF	Select DTS signal "ON" or "OFF". Note: When using a Digital Amplifier without a DTS decoder, set DTS to "OFF".

PARENTAL

Enter password. Enter a number in 4 digits, then press ENTER.

(To confirm, enter password again, then press ENTER.)

- LEVEL:
- 5
 - 8
 - 7
 - 6
 - 5
 - 4
 - 3
 - 2
 - 1
 - OFF

STANDARD: USA USA

CHANGE PASSWORD

Change password. Enter a number in 4 digits, then press ENTER.

To confirm, enter password again, then press ENTER.

Invalid password.
Enter password again.

Parental control

MPAA (Motion Picture Association of America) Guideline is rating system that provide advance cautionary information to parent about the content of movie programmes.

The parental lock level is equivalent to the following MPAA Rating System.

- Level 7: NC-17 (No one 17 and under admitted)
- Level 6: R (Restricted)
- Level 4: PG13 (Parental guidance cautioned)
- Level 3: PG (Parental guidance suggested)
- Level 1: G (General audiences)

Some DVD discs contain a restriction level which enables parents to prevent playback of discs by children. This DVD player is equipped with a password designed to prevent children changing the level.

You cannot play DVD discs rated higher than the level you selected unless you cancel the parental lock function. For example, when you select level "5", the DVD player will not play discs with ratings of "6", "7" or "8". The information will appear on the TV screen.

If you forget the password...

Enter "788444" to clear the current password.
Enter a new password and set the parental lock level again.

Note:
DVD discs may or may not respond to the parental lock settings. Make sure this function works with your DVD discs.

CLEANING THE UNIT

Clean the outside of the unit with a clean soft cloth moistened with lukewarm water. Do not use benzene, thinner or alcohol since they will mar the finish of the surfaces.

LANGUAGE CODE LIST

Code	Language	Code	Language	Code	Language	Code	Language
6565	Afar	7079	Faroese	7678	Lingala	8375	Slovak
6566	Abkhazian	7082	French	7679	Laothian	8376	Slovenian
6570	Afrikaans	7089	Frisian	7684	Lithuanian	8377	Samoaan
6577	Amharic	7165	Irish	7686	Latvian, Lettish	8378	Shona
6582	Arabic	7168	Scottish Gaelic	7771	Malagasy	8379	Somali
6583	Assamese	7176	Galician	7773	Maori	8381	Albanian
6589	Aymara	7178	Guarani	7775	Macedonian	8382	Serbian
6590	Azerbaijani	7185	Gujarati	7776	Malayalam	8385	Sundanese
6665	Bashkir	7265	Hausa	7778	Mongolian	8386	Swedish
6669	Byelorussian	7273	Hindi	7779	Moldavian	8387	Swahili
6671	Bulgarian	7282	Croatian	7782	Marathi	8465	Tamil
6672	Bihari	7285	Hungarian	7783	Malay	8469	Telugu
6678	Bengali; Bangla	7289	Armenian	7784	Maltese	8471	Tajik
6679	Tibetan	7365	Interlingua	7789	Burmese	8472	Thai
6682	Breton	7378	Indonesian	7865	Nauru	8473	Tigrinya
6765	Catalan	7383	Icelandic	7869	Nepali	8475	Turkmen
6779	Corsican	7384	Italian	7876	Dutch	8476	Tagalog
6783	Czech	7387	Hebrew	7879	Norwegian	8479	Tonga
6789	Welsh	7465	Japanese	7982	Oriya	8482	Turkish
6865	Danish	7473	Yiddish	8065	Punjabi	8484	Tatar
6869	German	7487	Javanese	8076	Polish	8487	Twi
6890	Bhutani	7565	Georgian	8083	Pashto, Pushto	8575	Ukrainian
6976	Greek	7575	Kazakh	8084	Portuguese	8582	Urdu
6978	English	7576	Greenlandic	8185	Quechua	8590	Uzbek
6979	Esperanto	7577	Cambodian	8277	Rhaeto-Romance	8673	Vietnamese
6983	Spanish	7578	Kannada	8279	Romanian	8679	Volapük
6984	Estonian	7579	Korean	8285	Russian	8779	Wolof
6985	Basque	7583	Kashmiri	8365	Sanskrit	8872	Xhosa
7065	Persian	7585	Kurdish	8368	Sindhi	8979	Yoruba
7073	Finnish	7589	Kirghiz	8372	Serbo-Croatian	9072	Chinese
7074	Fiji	7665	Latin	8373	Singhalese	9085	Zulu

TROUBLESHOOTING GUIDE

If you have followed the instructions and are having difficulty operation the unit, locate the SYMPTOM in the left column below. Check the corresponding POSSIBLE CAUSE and CORRECTIVE ACTION columns to locate and remedy the problem.

SYMPTOM	POSSIBLE CAUSE	CORRECTIVE ACTION
The power is on, but the player does not work.	No disc is loaded.	Load a disc.
No picture.	An unplayable disc is loaded.	Load a playable disc. (Check the disc logo, type, colour system and regional code.)
	The TV is not set to receive signal from the player.	Select the correct input function on the TV.
	No video connection.	Connect the video cable to the appropriate socket.
No sound.	No audio connections.	Connect the audio cables to the appropriate sockets.
The playback picture is poor.	An unplayable disc is loaded.	Load a playable disc. (Check the disc logo, type, colour system and regional code.)
"⊘" appears on the TV screen.	The selected function does not operate on the disc now.	The feature or action cannot be completed at this time because: <ul style="list-style-type: none"> • The feature is not available at the moment. • The DVD software restricts it. • The DVD software does not support the feature (e.g., angles).
The player does not start play.	No disc is loaded.	Load a disc.
	An unplayable disc is loaded.	Load a playable disc. (Check the disc logo, type, colour system and regional code.)
	The disc is loaded with the label side down.	Load the disc on the disc tray correctly.
	The disc is dirty.	Clean the disc or replace it.
	"PARENTAL" is set.	Cancel the parental lock function or change the rating level. Reset it after play.
The operation or display is not normal.	The player must be reset.	<ol style="list-style-type: none"> 1. Disconnect the mains lead. 2. Reconnect the mains lead. 3. Resume operation.
The remote control does not work properly.	The batteries in the remote control are weak, or installed incorrectly.	Check the battery polarity (+ or -). Replace the batteries.
	The remote control is not aimed at the remote sensor window.	Aim the remote control at the remote sensor window.

Additional explanations for the system DC-X5D

ARRANGEMENT

COMPONENT SYSTEM COMPOSITION

System DC-X5D

Tuner/Amplifier: JCX-X5

DVD player: DVD-X5

Speaker system: SX-X5L and SX-X5R

Remote control: RB-007 and RB-5100

Tape deck: SANYO RD-X5 (Option)

MD deck: SANYO MDG-X5 (Option)

Note:

- Simultaneous connection of DVD player (DVD-X5) and CD changer (CP-X5) is not possible.
- RB-5100 Remote control can be used for only the DVD player. RB-007 Remote control can be used for the Tuner/Amplifier, Tape deck, MD deck of the system and some functions of the DVD player.

Example 1

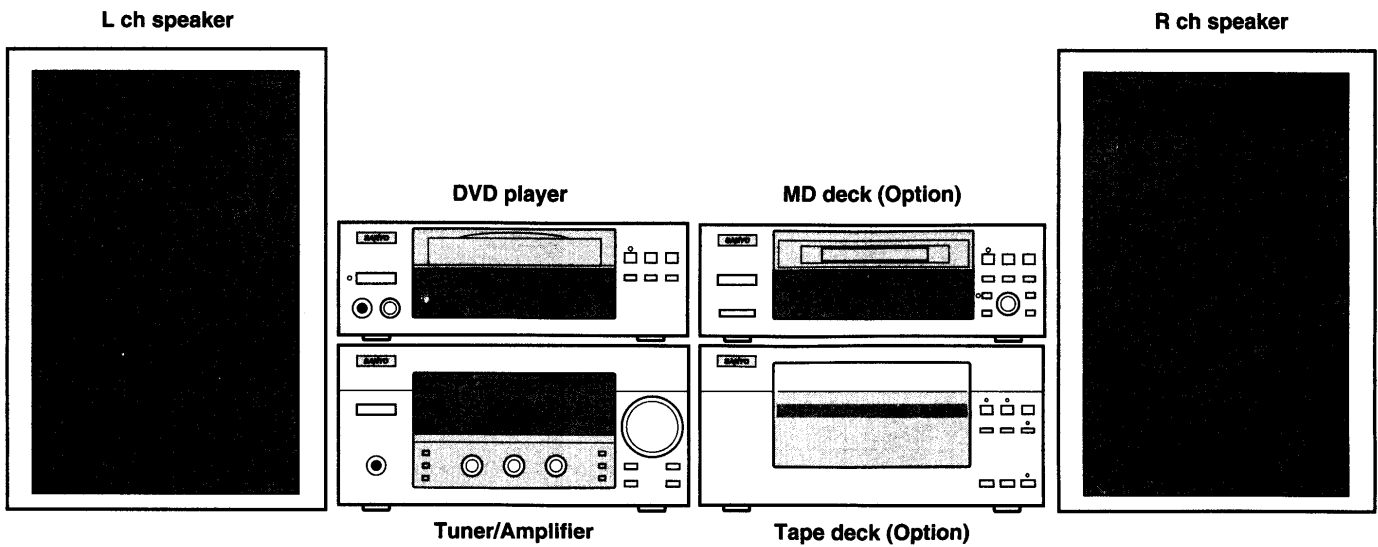

Example 2

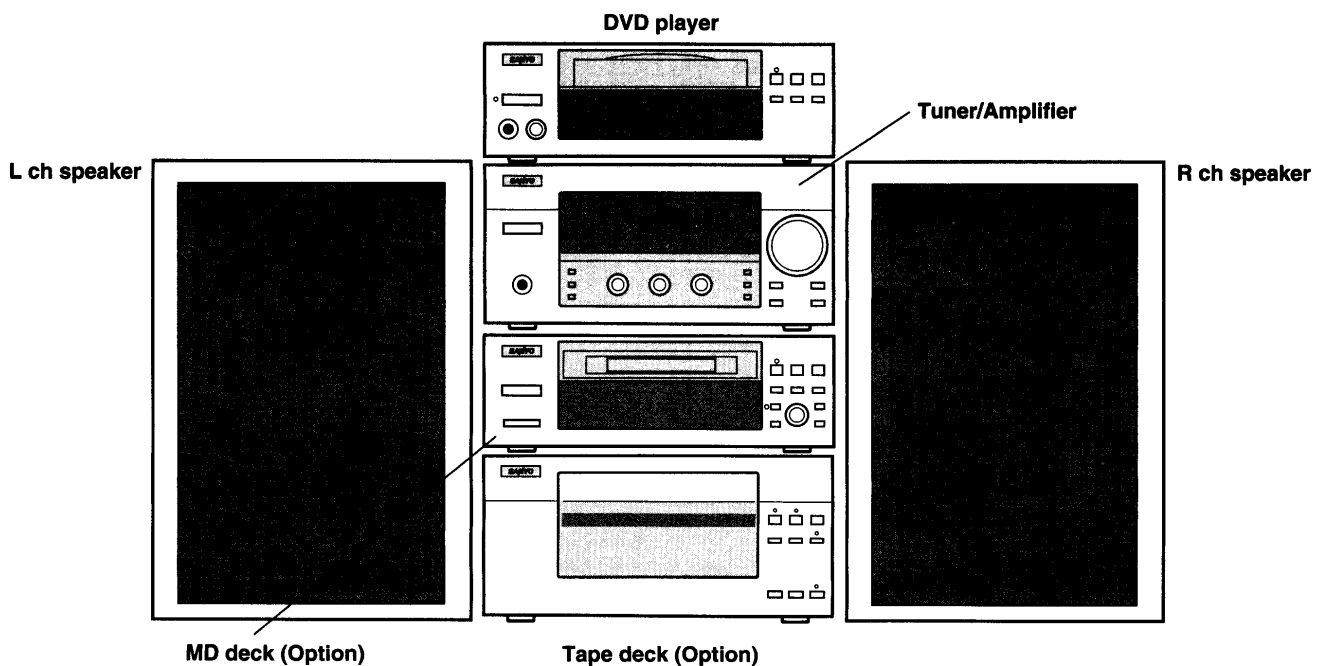

SYSTEM CONNECTIONS

When using only the system DC-X5D (DVD player and Tuner/Amplifier)

DVD player

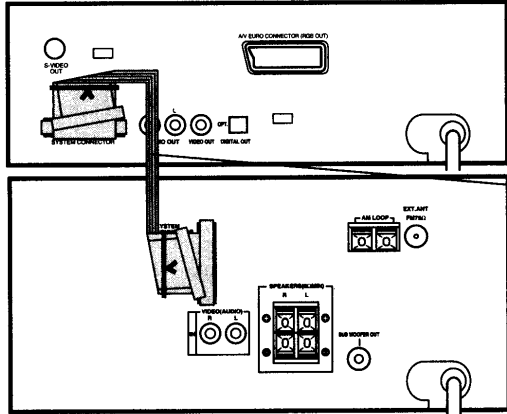

Tuner/Amplifier

The flat connection lead is provided as shown.

To the DVD player

To the Tuner/Amplifier

Do not remove the fixer and protective tape.

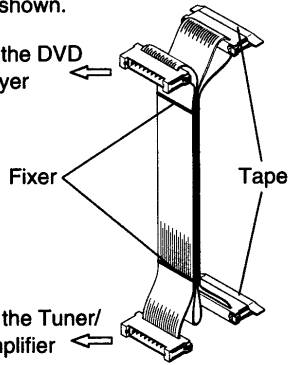

Notes on the flat connection lead

When using the system DC-X5D and optional Tape deck and/or MD deck, remove the fixer and protective tape before connecting.

- Do not remove the tape on the plug that is not used.

Note:

- Do not connect the mains lead to an AC outlet until all connections have been made.
- The system is not completely disconnected from the mains when the \odot /ON button is set to the \odot position.
- To prevent a noise interference from the mains, the core clamp is attached to the mains lead. Do not remove it.

For System DC-X5D

Before connecting, remove the cap on this socket.

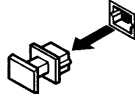

To connect, push the middle of the plug and insert it until it clicks.

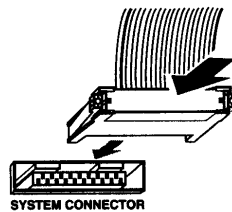

If you have difficulty inserting the plug, turn it over and reinsert it.

To disconnect, while pressing both latches, remove the plug.

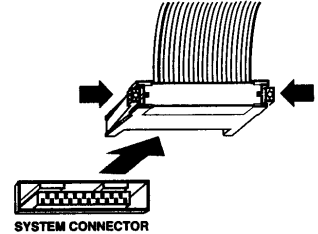

Digital equipment

Video/Auxiliary equipment

(Optical cable, not supplied)

(Optical cable, supplied with the MD deck)

(Audio cable, not supplied)

MD deck

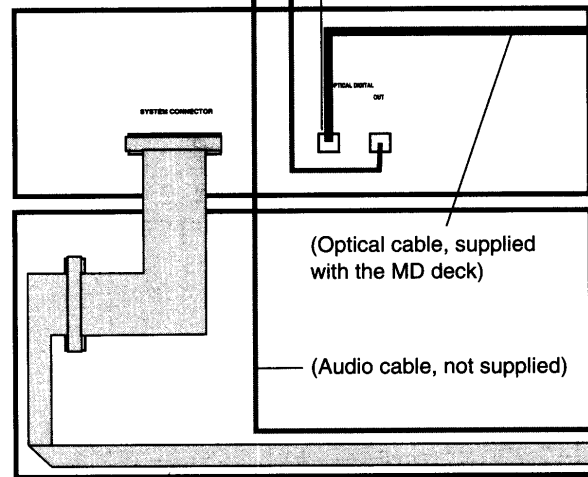

Tape deck

Amplified subwoofer

(Audio cable, not supplied)

DVD player

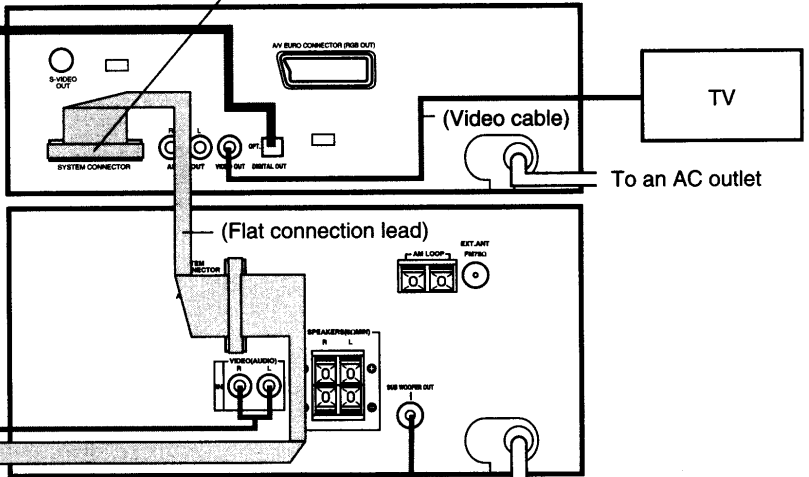

Tuner/Amplifier

To an AC outlet

TV

Connect the video cable from the video input socket of a TV to the VIDEO OUT socket (DVD player).

- You can connect a TV with a S-video cable or a EURO-AV cable instead of the video cable. (See Page 4.)

Video/Auxiliary equipment

Connect an audio cable (not supplied) from the audio output sockets of a video/auxiliary equipment to the VIDEO (AUDIO) sockets.

Subwoofer

Connect an amplified subwoofer (not supplied) to the SUB WOOFER OUT socket.

Digital equipment

The OPTICAL DIGITAL OUT socket (MD deck) reproduces MD's digital sound to your digital equipment. The socket can be connected to the digital equipment which has an optical input socket.

Turning the power on and off

Press the \odot /ON button (Tuner/Amplifier or RB-007 Remote control). All the units turn on. The displays light and "WELCOME" appears briefly. (After connecting the mains lead, when you press the \odot /ON button for the first time, the volume reset feature automatically sets the initial volume level.)

To turn the power off, press the \odot /ON button again. All the units turn off.

- When the mains lead is connected to the AC outlet, the unit will respond to commands from the remote control.

Note:

Press the \odot /ON button (DVD player or RB-5100 Remote control). Only the DVD player turns on. Press it again. Only the DVD player turns off.

Eco (low power consumption) standby mode

The unit is set to the eco standby mode when it is shipped from the factory. When turning the power off, no display appears on the display. To cancel this mode, press the CLOCK/ECO button (in the power is off). The clock appears. Press it again to return to the eco standby mode.

Direct start function (RB-007 Remote control only)

If the following buttons are pressed when the unit is in standby, the unit turns on automatically and the selected function is set.

CD \blacktriangleright , TUNER/BAND, VIDEO, TAPE \blacktriangleright , TAPE \blacktriangleleft , MD \blacktriangleright

Selecting the function

Press the INPUT button to select the desired function (input source). Each time the button is pressed, the display changes as follows:

DVD/CD \rightarrow TAPE \rightarrow TUNER \rightarrow VIDEO:AUX \rightarrow MD \rightarrow

If the following buttons are pressed (except during recording), the function is automatically selected.

PLAY, OPEN/CLOSE (DVD player), BAND (Tuner/Amplifier), REV PLAY, FWD PLAY (Tape deck), PLAY (MD deck)

- When the function selection is changed, disc play, tape playback or MD play is automatically stopped.

Adjusting the volume

Turn the VOLUME control, (or press the + or - VOLUME button on the RB-007 remote control). The volume level appears on the display (VOL 0 ~ VOL MAX).

Pure active surround system (PASS)

This newly developed surround system gives natural spread-out atmosphere. Press the PASS button to select the desired PASS effect.

SURR OFF \rightarrow SURR HI \rightarrow SURR LOW \rightarrow SURR OFF \rightarrow ...

Adjusting the tone

Turn the BASS control to adjust the bass sound. The bass level appears on the display (BASS -5 ~ 0 ~ +5).

Turn the TREBLE control to adjust the treble sound. The treble level appears (TREBL -5 ~ 0 ~ +5).

To reduce the volume temporarily (muting)

(RB-007 Remote control only)

Press the MUTE-20dB button. "MUTE" blinks on the display. To restore the previous volume setting, press the MUTE-20dB button again. "MUTE" disappears.

Bass boost (RB-007 Remote control only)

Press the SUPER BASS button to enhance the bass sound. "BASS" appears on the display.

- The initial setting of this function is ON.

Adjusting the displays brightness (Tuner/Amplifier, DVD player and MD deck) (Main unit only)

While pressing the MEMORY button, press the CLOCK/ECO button.

DIMMER 1 \rightarrow DIMMER 2 \rightarrow DIMMER 0 (initial setting)

To turn off the blue lights on the DVD player and MD deck, select "DIMMER 2".

WHAT TO DO IF...

If the operation of the system or display is not normal,

1. Disconnect the mains lead.
2. Press the RESET button (bottom of the Tuner/Amplifier) for at least 30 seconds.
3. Connect the mains lead.
4. Resume the operation.

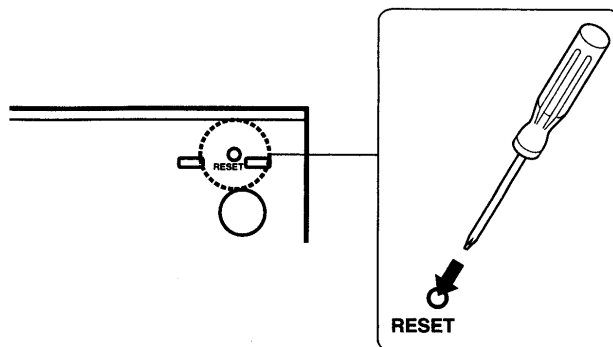

Turn on the TV and select the channel for the DVD player.

Note:

- Do not touch the disc tray while it is moving.
- Never place anything except a disc on the disc tray. Foreign objects can damage the unit.
- Do not apply excessive force to the disc tray.
- Discs must be placed on the disc tray one at a time.

If a disc is loaded, you can turn the system on and begin play immediately by pressing the CD ► button (RB-007 Remote control only).

Press the \odot /ON button (DVD player or RB-5100 Remote control) to turn the power on if necessary.

1. Press the INPUT button (Tuner/Amplifier) to select "DVD/CD" function.
2. Press the OPEN/CLOSE button (DVD player or RB-5100 Remote control). The disc tray opens.
3. Place the disc with the label facing up on the disc tray.

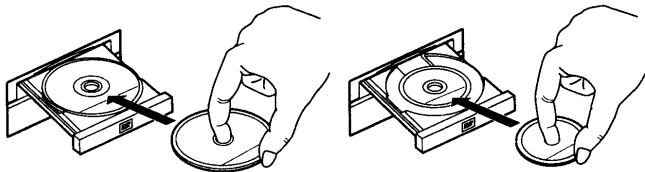

For 12 cm disc

For 8 cm disc

4. Press the PLAY (DVD player or RB-5100 Remote control) or CD ► (RB-007 Remote control) button. The PLAY indicator lights. The disc tray closes then play starts automatically.

DVD player:

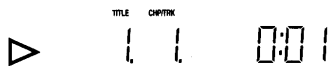

Tuner/Amplifier:

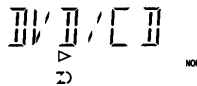

When the "DVD/CD" function is selected, some discs will start play automatically.

If a menu screen appears on the TV screen...

Press the ▲, ►, ▼ or ◀ button (or the number buttons), then press the ENT button (RB-5100 Remote control) to select the desired item. Playback of the selected item will start.

5. Press the STOP (DVD player or RB-5100 Remote control) or ■ (RB-007 Remote control) button once. The player memories the point where you stopped. If you press the PLAY (DVD player or RB-5100 Remote control) or CD ► (RB-007 Remote control) button, play starts automatically from the point where you stopped.

Note:

If the STOP (DVD player or RB-5100 Remote control) or ■ (RB-007 Remote control) button is pressed twice, the player stops completely.

For more details, please refer to "BASIC OPERATION" and "VARIOUS PLAYING FUNCTIONS".

CD TO TAPE COMPUTER RECORDING

With computer recording, you can record a CD onto a cassette by pressing just one button.

Note: This operation can be possible only when CD is loaded.

1. Load the CD to be recorded.
2. Load the blank cassette for recording.
3. Press the REV MODE button to select "◀" mode.
4. Select "DVD/CD" function.
- For programmed recording, programme the material in advance.
 - 1) Follow steps 1-5 of "Programming procedure" under "Programmed play" on Page 9.
 - 2) Press the STOP button once (DVD player).
5. Make sure that the DVD player and tape deck are both in the stop mode.
6. Press the COMPU REC button. Once the button is pressed, all operations take place automatically. The COMPU REC indicator lights and "CD → TP" appears on the display.

The tape rewinds to the beginning, then recording starts in the forward direction from track 1 (or the first programmed track).

The FWD PLAY, REC PAUSE, COMPU REC (Tape deck), PLAY (DVD player) indicators light as recording begins. The following display appears.

DVD player:



Tuner/Amplifier:



When the end of the tape (side B) is reached, the DVD player and deck stop automatically.

- If the last track on the CD plays completely before the end of the tape, CD play stops automatically. Deck also stops.

Note:

- Recording starts automatically after 8 seconds, so the recording will not be interrupted by the leader tape at the beginning of tape.
- A 5-second blank space is automatically recorded at the end of each track.
- The recording cannot be paused.

To stop recording at any time, press the STOP button (DVD player or Tape deck).

MANUAL RECORDING

1. Load the cassette.
2. **DVD, VCD, CD to Tape recording**
Select "DVD/CD" function and play a disc.
- MD to Tape recording**
Select "MD" function and play a MD.
- Tuner to Tape recording**
Tune in the radio.
- Video/AUX to Tape recording**
Select "VIDEO:AUX" function and play a video cassette or auxiliary source.
3. Press the REC PAUSE button. The REC PAUSE indicator lights and both PLAY indicators blink. The tape deck is set to the recording pause mode.
4. Press the FWD PLAY or REV PLAY button. Recording starts.
5. Press the STOP button to stop recording. (Disc or MD play continues.)

CD to Tape/MD to Tape synchronous recording

1. Load the cassette.
2. Load the CD (Note: This operation can be possible only when CD is loaded.) and select "DVD/CD" function, or load the MD and select "MD" function.
 - For programmed recording, programme the material in advance.
3. Press the REC PAUSE button. The tape deck is set to the recording pause mode.
4. Press the PLAY button (DVD player or MD deck). Recording starts in the forward direction.
 - If CD or MD play pauses, recording also pauses and CD or MD play resumes, recording also resumes.
5. Press the STOP button (DVD player or MD deck) to stop recording.
 - When the STOP button (Tape deck) is pressed, CD or MD play continues.

Temporarily stop recording

Press the REC PAUSE button. Press the FWD or REV PLAY button (to match the blinking PLAY indicator) to resume recording.

- During recording pause mode, disc or MD play continues.

When beat interference is heard (Main unit only)

A high-pitched noise called "beat" is sometimes heard during the recording of radio broadcasts. If this occurs,

While pressing the ◀◀ button, press the ▶▶ button to select "Bc-1" or "Bc-2". Select the setting that gives the best results.

CD TO MD COMPUTER RECORDING

With computer recording, you can record a CD onto a MD by using just one button.

Note: This operation can be possible only when CD is loaded.

1. Load the CD to be recorded.
2. Load the MD for recording.
3. Select "DVD/CD" function.
For programmed recording, programme the material in advance.
 - 1) Follow steps 1-5 of "Programming procedure" under "Programmed play" on Page 9.
 - 2) Press the STOP button once (DVD player).
4. Make sure that the DVD player and MD deck are both in the stop mode.
5. Press the COMPU REC button. The COMPU REC indicator blinks. "COMPU REC", then "All Erase?" appears on the MD display.

 All Erase?

"CD -> MD" appears on the Tuner/Amplifier display.

- Recording starts automatically if the MD is completely blank.
6. Press the COMPU REC button. "REC START" appears briefly. Once the button is pressed, all operations take place automatically. Digital recording mode is selected automatically and recording starts from track 1 (or the first programmed track).
 - If "No Digital" blinks, check the connection of the optical cable (DVD player to MD deck).

The PLAY, COMPU REC indicators (MD deck) and PLAY indicator (DVD player) light as recording begins. The following display appears.

DVD player:



Tuner/Amplifier:



MD deck:

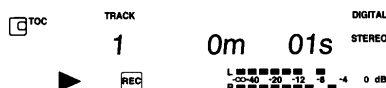

- If TOC on CD was not read, recording will not start.

When the recording is completed, the DVD player and MD deck stop automatically. "REC END" appears briefly.

Note:

- If the MD was recorded previously, the MD is erased first then recorded.
- Track numbers are assigned automatically in the same order as on the CD.
- The recording cannot be paused.

To stop recording at any time, press the STOP button (DVD player or MD deck).

Current track one-touch recording

When you want to record music as you listen, press the COMPU REC button.

The DVD player skips to the beginning of the track currently playing. Then recording starts. (The new recording starts after the previously recorded portion.)

When the current track recording is finished, the DVD player and MD deck stop automatically.

MANUAL RECORDING

Previously recorded contents of the MD remain and the selected source is recorded on the blank portion of the MD.

Note:

Do not select "MD" function. If "MD" is selected, the deck may be set to the overwriting mode.

1. Load the MD.
2. **DVD, VCD, CD to MD recording**
Select "DVD/CD" function and play a disc.
Tape to MD recording
Select "TAPE" function and play a cassette.
Tuner to MD recording
Tune in the radio.
Video/AUX to MD recording
Select "VIDEO:AUX" function and play a video cassette or auxiliary source.
3. Press the REC button. The PLAY indicator blinks and the MD deck is set to the recording pause mode. "New" and "0m 00s" blink alternately.
 - If disc recording is selected, "DIGITAL" appears.
4. Press the INPUT button to select the digital or analog input mode if required.
 - DIGITAL: Digital input mode, "DIGITAL" appears.
 - ANALOG: Analog input mode, "ANALOG" appears.
 - If "No Digital" blinks, select "ANALOG".
5. While pressing the SHIFT button, press the REC MODE button on the RB-007 remote control to select the stereo or monaural recording mode.
 - STEREO REC: Stereo recording
The sound is recorded in high quality mode. "STEREO" appears.
 - MONO REC: Monaural recording
Twice the normal recording time is available. "MONO" appears.
6. Press the PLAY or PAUSE button. Recording starts.

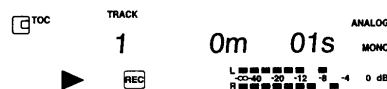

- If the REC button is pressed during recording, the track number is added automatically and recording continues.
7. Press the STOP button to stop recording. (Disc play or tape playback continues.)

CD to MD/Tape to MD synchronous recording

1. Load the MD.
2. Load the CD (Note: This operation can be possible only when CD is loaded.) and select "DVD/CD" function, or load the cassette and select "TAPE" function.
 - For CD programmed recording, programme the material in advance.
3. Press the REC button. The MD deck is set to the recording pause mode.
4. Press the PLAY button (DVD player), or press the FWD or REV PLAY button (Tape deck). Recording starts.
 - If CD play pauses, recording also pauses and CD play resumes, recording also resumes. At this time, the track number is added automatically.
5. Press the STOP button (DVD player or Tape deck) to stop recording.
 - When the STOP button (MD deck) is pressed, CD play or tape playback continues.

Temporarily stop recording

Press the PAUSE button. The PLAY indicator blinks. To resume recording, press the PLAY or PAUSE button. At this time, the track number is added automatically.

- During recording pause mode, disc play or tape playback continues.

CD to Tape/CD to MD parallel recording

Note: This operation can be possible only when CD is loaded.

1. Load the cassette and MD.
2. Load the CD and select "DVD/CD" function.
3. Press the REC PAUSE button (Tape deck). The tape deck is set to the recording pause mode.
Press the REC button (MD deck). The MD deck is set to the recording pause mode.
4. Press the PLAY button (DVD player). CD to tape and MD parallel recording starts.
5. Press the STOP button (DVD player) to stop recording.

Marking the track number automatically

Track automatic marker

If there is a quiet passage in the music lasting more than 2 seconds, when recording from a tape or VIDEO, a new track number is made automatically.

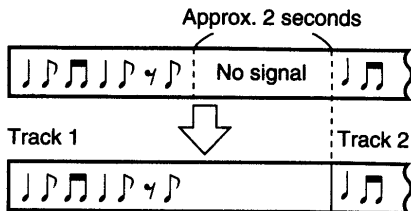

While pressing the SHIFT button, press the AUTO MARKER button on the RB-007 remote control to display "Tr.MARK" in the stop or recording pause mode.

To cancel the automatic marker, perform the same operation to turn the "Tr.MARK" indication off.

RECORD ON A PRE-RECORDED MD

You can record from the beginning of any pre-recorded track on an MD (Overwriting).

If you do so, previous records (track and track name) will be erased.

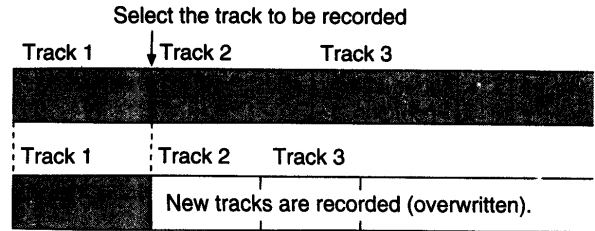

1. Load the MD and select "MD" function.
2. Turn the MULTI JOG control to select the track to be started a new recording.
3. Press the REC button. The PLAY indicator blinks and the MD deck is set to the recording pause mode. "Over Rec" and "0m 00s" blink alternately.
4. Select the desired function to be recorded.
5. Tuner or Video/AUX function: Press the PLAY or PAUSE button (MD deck).
DVD/CD function: Press the PLAY button (DVD player).
Note: This operation can be possible only when CD is loaded.
Tape function: Press the FWD or REV PLAY button (Tape deck). "TRACK" blinks and recording starts.
6. Tuner or Video/AUX function: Press the STOP button (MD deck).
DVD/CD function: Press the STOP button (DVD player).
Tape function: Press the STOP button (Tape deck).
Recording stops.

SPECIFICATIONS

Playback system:

DVD-Video, Video CD, CD

Playback standard:

PAL or NTSC

Laser:

Semiconductor laser, wavelength: 650 nm

Laser output (Continuous wave max.):

1 mW (DVD)

0.5 mW (CD)

Frequency range (digital audio):

4 Hz to 44 kHz (DVD fs: 96 kHz)

Signal to noise ratio:

More than 105 dB

Harmonic distortion (digital audio):

0.003 %

Wow and flutter:

Below measurable level

Outputs:**DIGITAL OUT:**

For optical cable

AV EURO CONNECTOR:

For Euro-AV cable

S-VIDEO OUT:

Y: 1.0 Vp-p (75 Ω) NTSC, 1.0 Vp-p (75 Ω) PAL

C: 0.286 Vp-p (75 Ω) NTSC, 0.3 Vp-p (75 Ω) PAL

VIDEO OUT:

1.0 Vp-p (75 Ω)

AUDIO OUT:

1.9 V rms

Power requirements:

AC 230 V, 50 Hz

Power consumption:

16 W

Less than 2 W (standby mode)

Dimensions:

270(W) x 87(H) x 282(D) mm

Weight:

2.4 kg

IMPORTANT INFORMATION

Because its products are subject to continuous improvement, SANYO reserves the right to modify product designs and specifications without notice and without incurring any obligation.

GUARANTEE TO CUSTOMER

Sanyo Europe Ltd. (the Company) guarantees to the initial retail purchaser that if this equipment is or becomes defective and that, in the opinion of the Company, the defect is due to faulty material or workmanship the Company will, for a period of 12 calendar months from the date of sale to the original purchaser repair or replace, at its sole option, free of charge, any such defective component part of the equipment, always provided that: -

1. The equipment has at all times been used in accordance with the operating instructions issued by the Company, and has not been connected to an electrical mains supply for which it has not been adjusted.
2. Accidental damage, or damage caused by negligence or misuse by the user, including leakage from exhausted batteries, is specifically excluded.
3. Unauthorised repairs, or any modification to the equipment which has not been expressly approved by the Company, shall render this guarantee null and void.
4. Failure due to fair wear and tear of any item, such as batteries, record playing stylus, and tape recording, playback and erase heads is specifically excluded.

This guarantee is not transferable and is only applicable within the United Kingdom (and the Republic of Ireland). Nothing in this express guarantee affects the statutory rights available to the purchaser of this equipment.

Note: This guarantee supersedes any other form of guarantee that may inadvertently have been enclosed with or attached to the product. (August 1978).

Dear customer

Thank you for buying Sanyo. This equipment should give you many years of pleasure and faithful service but in the event that a fault occurs, the following notes for your guidance may be helpful:-

1. PLEASE RETAIN YOUR PURCHASE RECEIPT WHICH WILL BE REQUIRED FOR SERVICE DURING GUARANTEE.
2. If your Sanyo equipment proves faulty during the period of guarantee, take it or send it back to the dealer who originally supplied it together with this guarantee and the proof of purchase. We have made arrangements with our approved dealers under which they will carry out in-guarantee service repairs on our behalf. In this way, we hope to reduce to a minimum the amount of time you will be without your equipment.
3. If for some reason it is impossible to return the equipment to the original supplier, please contact our Consumer Relations Department at the address below for further advice.
4. Should the equipment require servicing after the expiry of the guarantee period, take or send it to the original supplier or any other Sanyo dealer. He will be pleased to give you a quotation for the repair. If you are in any doubt about what to do, write to us at the address below or telephone:

**Consumer Relations Department,
Sanyo Europe Ltd.,
Sanyo House
Otterspool Way, Watford,
Hertfordshire WD2 8JX
Tel: Watford 246363**

R5

The SANYO logo consists of the word "SANYO" in a bold, sans-serif font. The letter "Y" is stylized with multiple vertical lines passing through it, creating a sense of motion or a multi-lens effect.

SANYO Electric Co., Ltd.